

Article number: 20818516
Description: E+G Collar nut
DIN 6331-M24

Measures

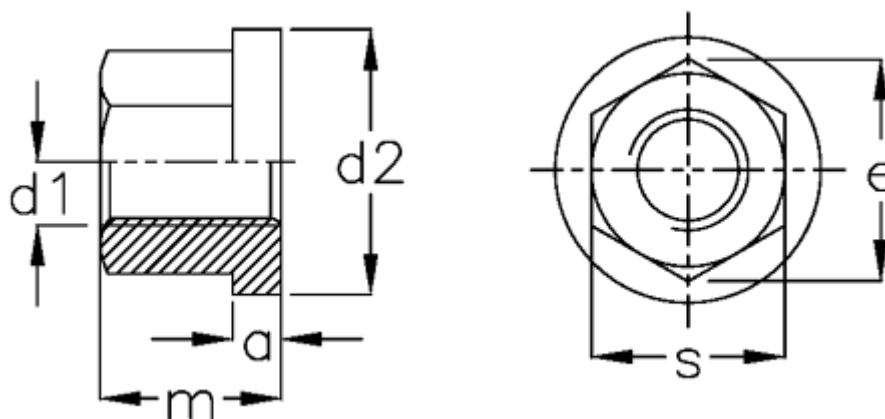

a = 6.0
d1 = M24
d2 = 45
e = 41.6
m = 36
s = 36